

Anwendungsfälle

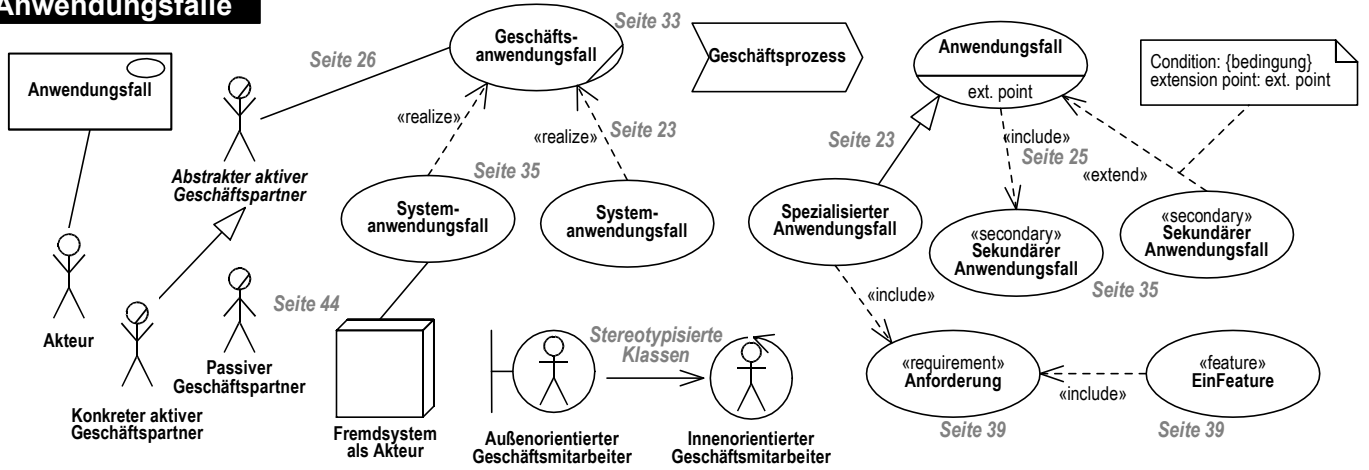

Klassen und Objekte

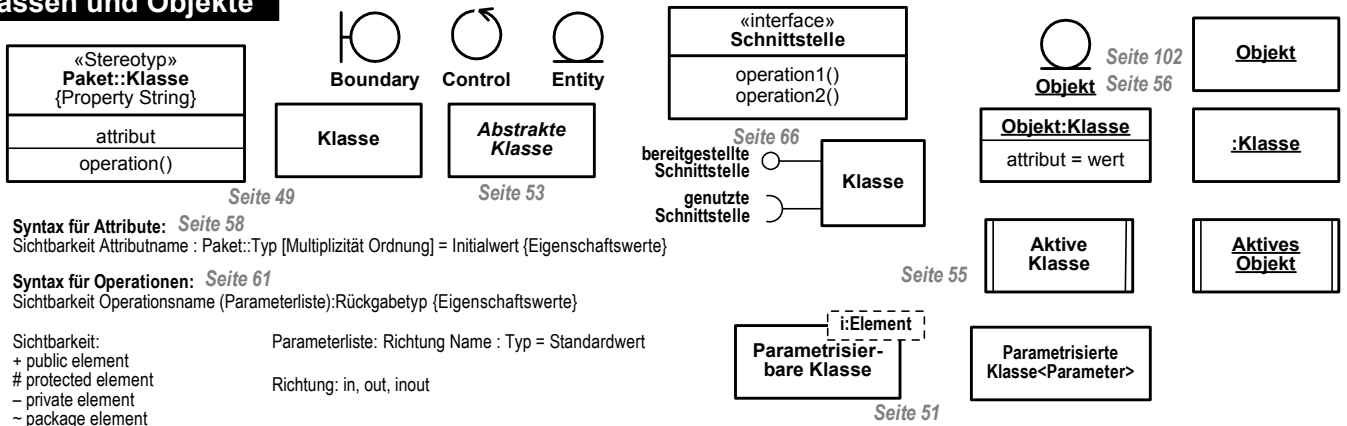

Beziehungen

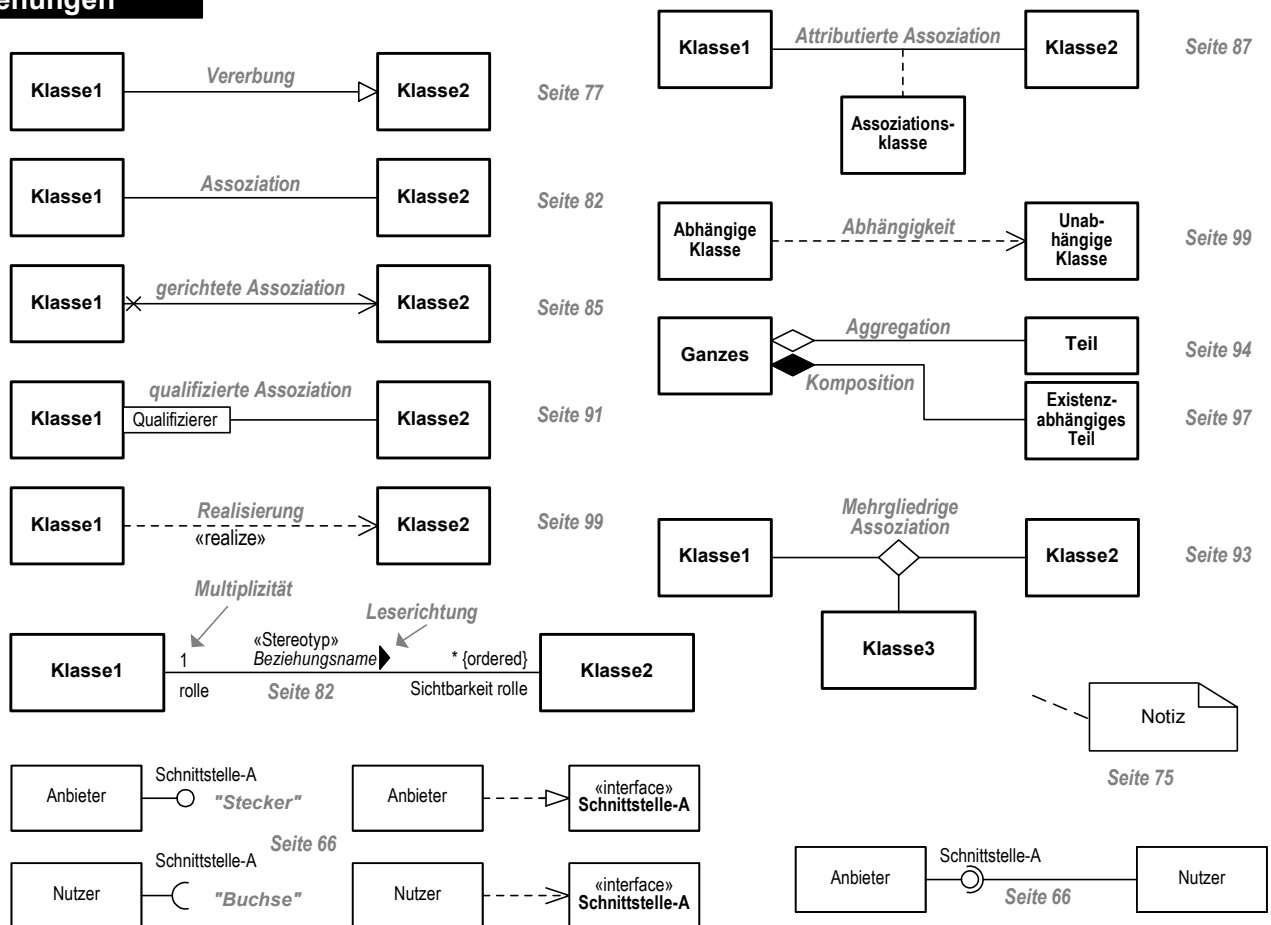

Die angegebenen Seitenzahlen beziehen sich auf "Die UML 2.0-Kurzreferenz für die Praxis", 3. Auflage, von Bernd Oestereich

Pakete

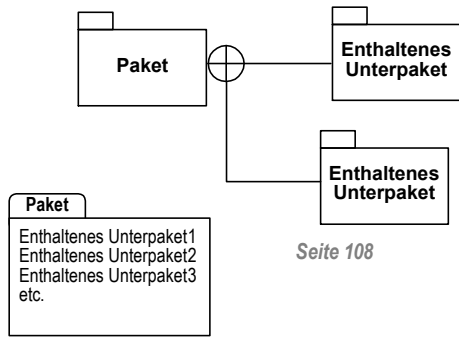

Deployment

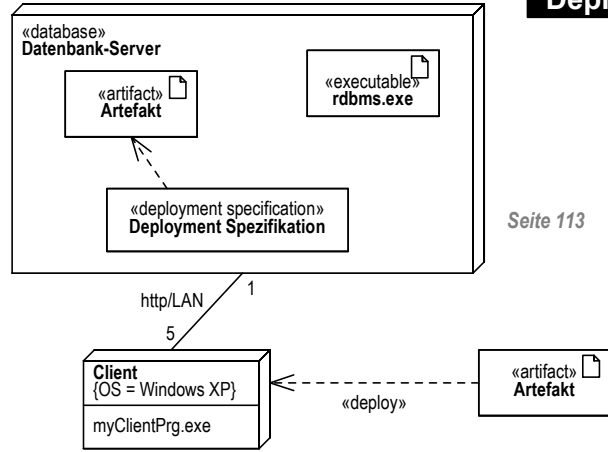

Komponenten

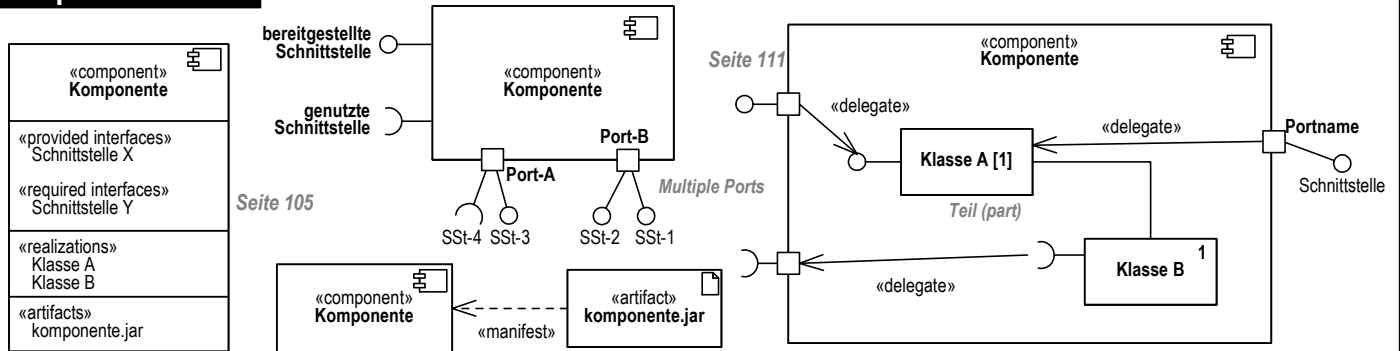

Zustandsdiagramm

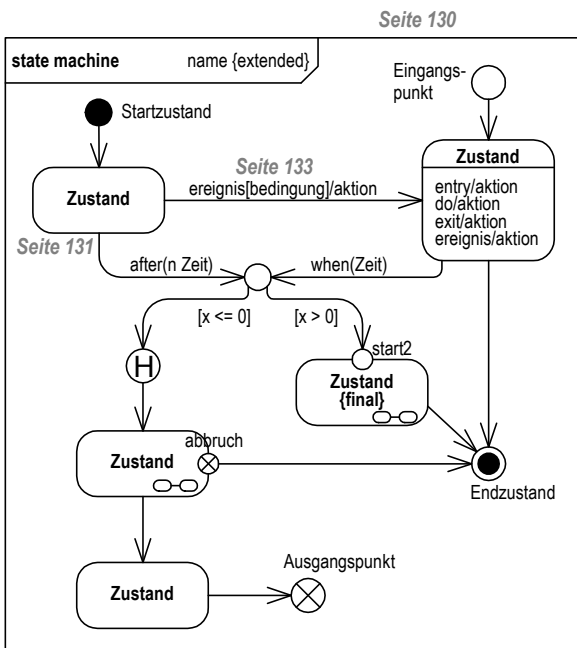

Kommunikationsdiagramm

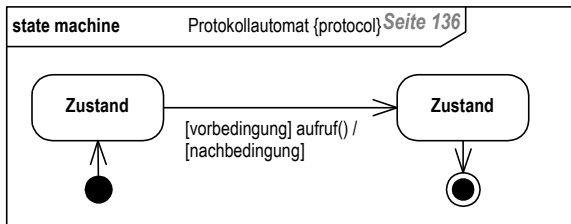
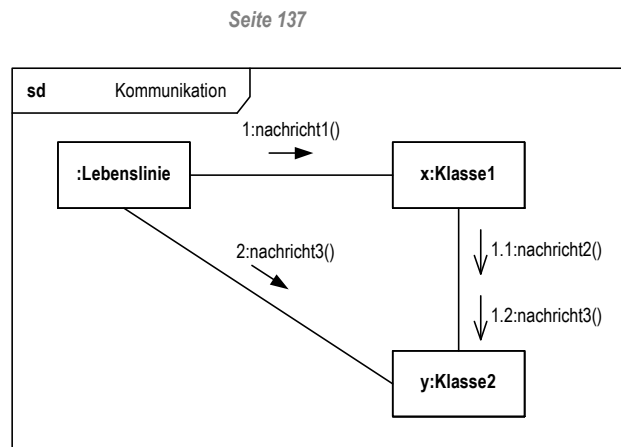

Timingdiagramm

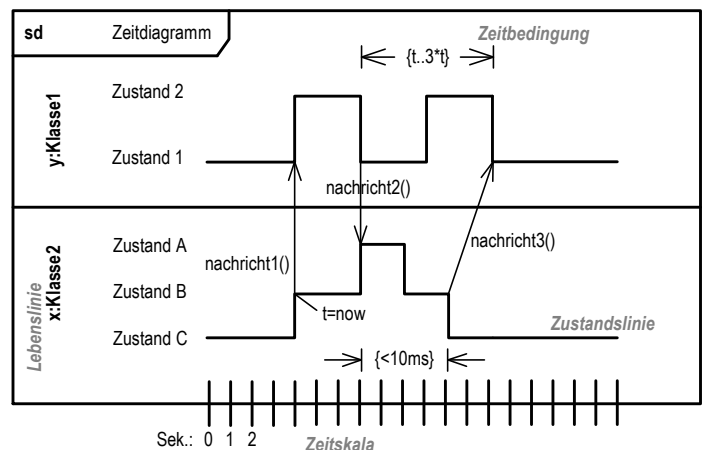

Die angegebenen Seitenzahlen beziehen sich auf "Die UML 2.0-Kurzreferenz für die Praxis", 3. Auflage, von Bernd Oestereich

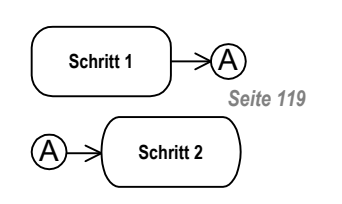
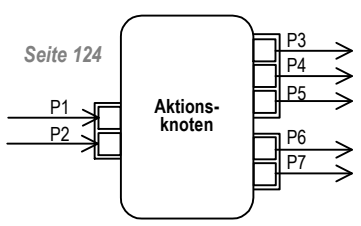
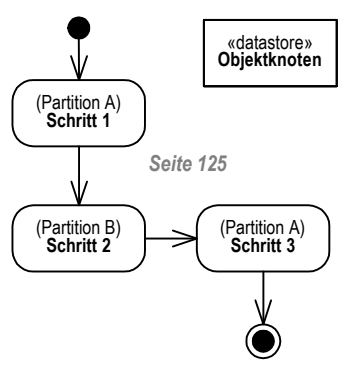
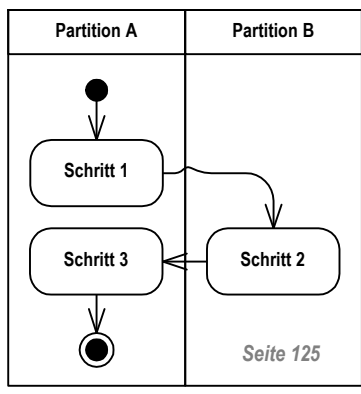
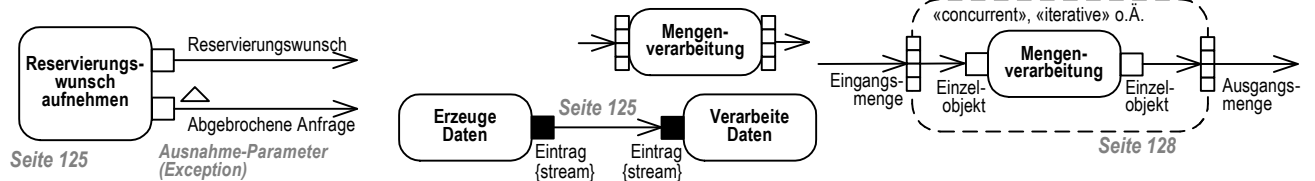
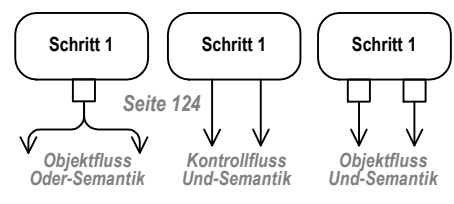
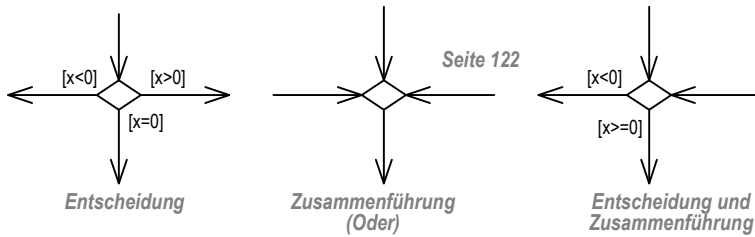
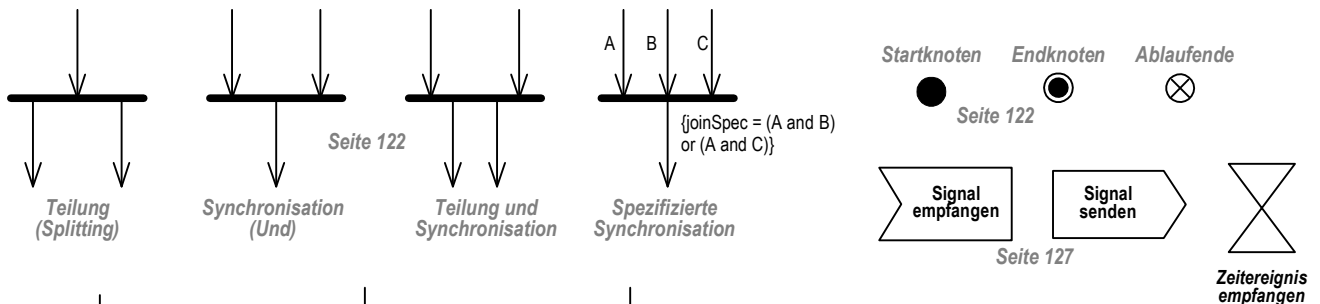
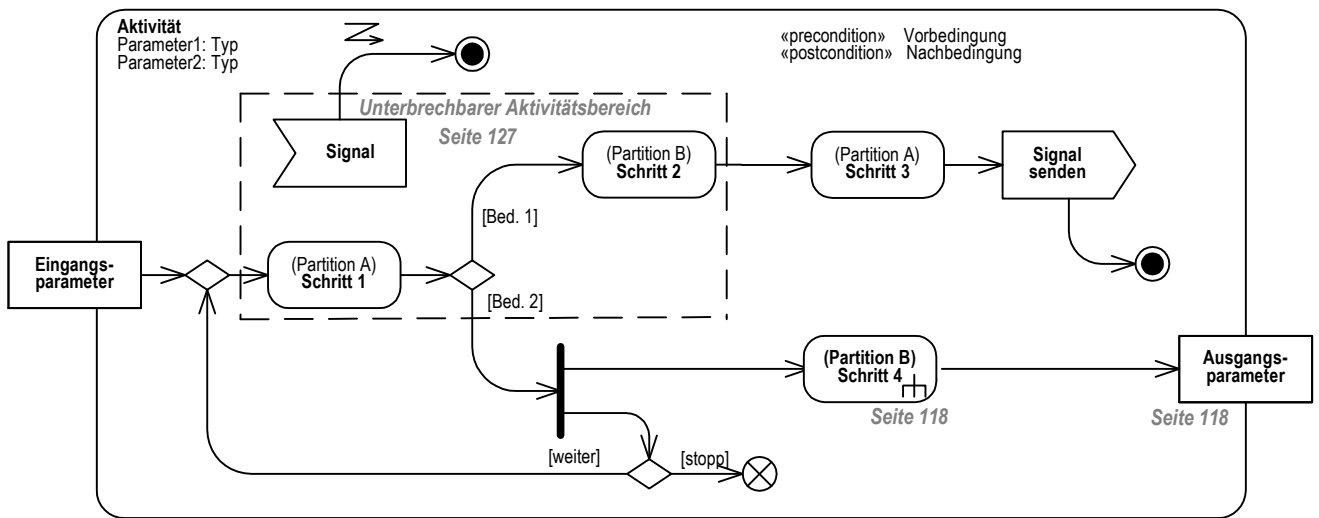

Interaktionsübersicht

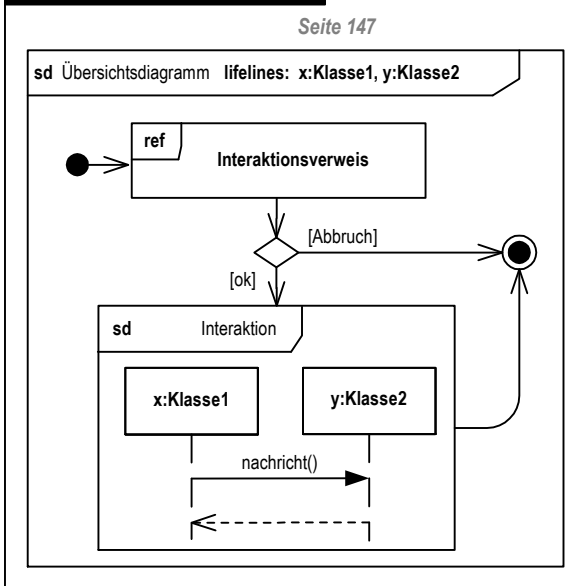

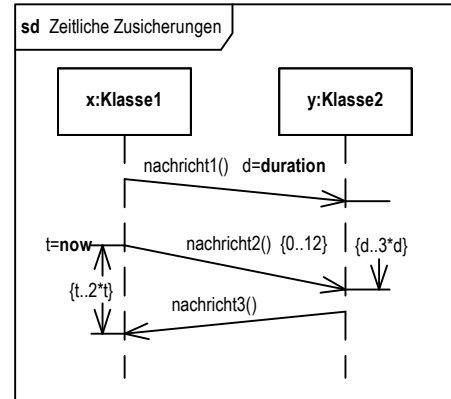
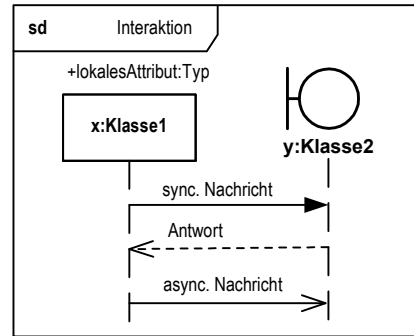
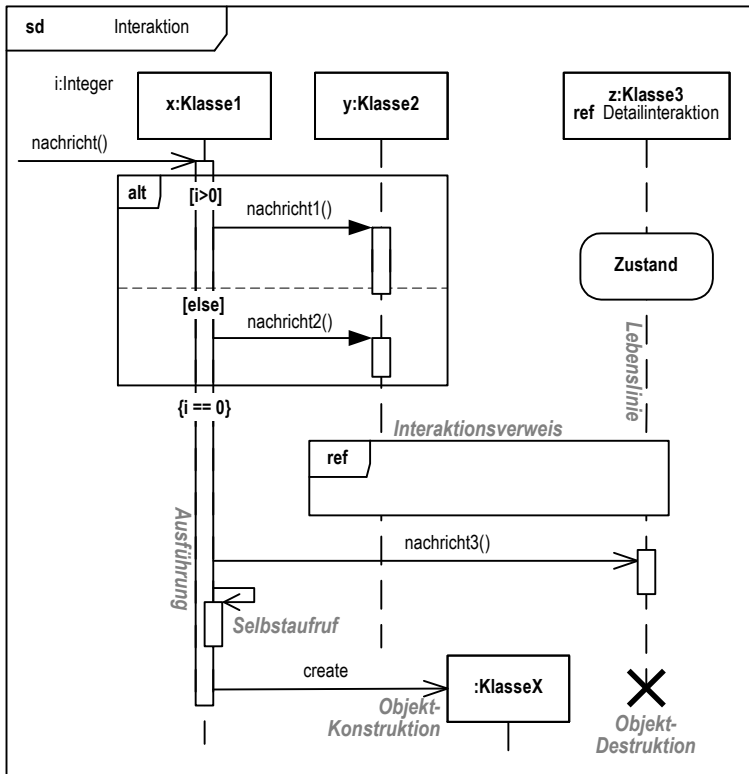

Diagrammübersicht

Die angegebenen Seitenzahlen beziehen sich auf "Die UML 2.0-Kurzreferenz für die Praxis", 3. Auflage, von Bernd Oestereich

